

Design and Implementation of Dual-Axis Solar Tracking System

Fathy M. Mustafa¹ and Seif A. Ahmed²

Electrical Engineering Department, Faculty of Engineering, Beni-Suef University, Beni-Suef, Egypt¹

Mechanical Engineering Department Faculty of Engineering, Beni-Suef University, Beni Suef, Egypt²

Abstract: Photovoltaic panels are used to collect solar energy and convert it into electrical energy. But these photovoltaic panels are inefficient as they are fixed only at a particular angle. This inefficiency can be decreased by designing a solar tracking system which changes its position automatically in accordance with the sun's movement. To track the sun in two directions that is elevation and azimuth, a dual-axis tracking system is developed to capture the maximum sun rays by tracking the movement of the sun in four different directions. One axis is azimuth which allows the solar panel to move left and right. The other axis is elevation and allows the panel to turn up and down. The aim of this paper is to present tracking system consists of Arduino controller, two motors (dc motor_linear) with gearbox arrangement on a mechanical structure to move the solar panel so that sun's beam is able to remain aligned with the solar panel, four sensors, which are mounted on the sides of the photo module by these sensors the solar tracking system becomes more sensitive and it allows to determining a more accurate location of the sun and PV panel as a solar collector. The results showed that the dual-axis solar tracking system is highly efficient for electrical energy output when compared with fixed solar system.

Keywords: Solar Tracking, Dual-Axis, Solar panel, Sensors and Arduino.

1. INTRODUCTION

The energy from the sun can be used to overcome the energy crisis generated by the scarcity of Fossil fuel resources. Solar energy is free and everywhere. Due to the decreasing of solar photovoltaic energy cost, it's superior in the renewable energy sources and widely utilized in many countries [1]. Solar power is one of the most widely used alternative pathway in the renewable energy domains or sources. The global demand/installation and production of PV modules are parallel increasing exponentially for the past 10 years with the largest share/development located in Europe followed by Asia Pacific region [2]. Solar energy is a very large, inexhaustible source of energy. The power from the sun intercepted by the earth is approximately (1.8×10^{11}) MW, which is many thousands of times larger than the present consumption rate on the earth of all commercial energy sources. Problem associated with the use of solar energy is that its availability varies widely with time. The variation in availability occurs daily because of the day night cycle and also seasonally because of the earth's orbit around the sun. To rectify the problems the solar panel should be such that it always receives maximum intensity of light. It has been seen since past that the efficiency of the solar panel is around 10-15% which is not meeting the desired load requirements. So there is a need of improving the panel efficiency through an economical way [3].

The most immediate and technologically attractive use of solar energy is through photovoltaic conversion. The physics of the PV cell (also called solar cell) is very similar to the classical p-n junction diode. In order to maximize the power output from the PV panels, one needs to keep the panels in an optimum position perpendicular to the solar radiation during the day. As such, it is necessary to have it equipped with a Sun tracker. Compared to a fixed panel, a mobile PV panel driven by a Sun tracker may boost consistently the energy gain of the PV panel [4]. There is a necessity to obtain high levels of solar energy to increase the reliance on renewable energy seriously to reduce the dependence on energy generated from the burning of fossil fuels. To extract maximum power from the sunlight, the solar tracker system is used to follow the path of the sun, which leads to maintain the PV panel perpendicular to the sunlight during daylight time [5]. A photovoltaic panel is a device used to capture the sun's radiation. These panels consist of an array of solar cells. The solar cells are made up of silicon (sand). They are then connected to complete a photovoltaic (solar) panel. When the sun rays are incident on the solar cell, due to the photovoltaic effect, light energy from the sun is used to convert it to electrical energy [6]. There are two types of movement of earth one is earth rotation and earth revolution. Earth's rotation is the rotation of the planet Earth around its own axis. The Earth rotates towards the East. One rotation completes in 23 hours, 56 minutes and 4 seconds. The other motion of Earth is around the Sun, called as Revolution of the Earth. Earth completes one complete revolution around the Sun in 365 days, 5 hours, 45 minutes and 46 seconds [7]. A solar tracker is a device for orienting a day lighting reflector, solar photovoltaic panel or concentrating solar reflector or lens toward the sun. Solar powered equipment works best when pointed at or near the sun, so a solar tracker can increase the effectiveness of such equipment over any fixed position, at the cost of additional system complexity. The tracker will enable the panel to follow the path of the sun and produce

more power as it absorbs more sunlight. Concentrators, especially in solar cell applications, require a high degree of accuracy to ensure that the concentrated sunlight is directed precisely to the powered device [8]. A solar tracker is used to track the orientation of the sun. In case of two-axis trackers the panel is positioned to track the orientation of the maximum sun light throughout the day by adjusting the tracker angles (both elevation and azimuth angles). A Photovoltaic (PV) device converts sunlight into electricity [9]. Though the technology of trapping the solar energy is studied and developed. It is in existence the process can be improved to increase efficiency and make it cost effective. As the sun moves across the sky during the day, it is advantageous to have the solar panels track the location of the sun, such that the panels are always perpendicular to the solar energy radiated by the sun. This will tend to maximize the amount of power absorbed by PV systems. It is estimated that using a tracking system, over a fixed system, can increase the power output by 30% - 60% [10].

Sun tracking solar system used mostly to increase the efficiency and power [11]. Among the proposed solutions for improving the efficiency of PV conversion, we can mention solar tracking, the optimization of solar cell configuration and geometry, new materials and technologies, etc. The solar tracking system is the most common method of increasing the efficiency of solar photo module [12]. The solar tracking system is the most common method of increasing the efficiency of solar photo module. This study presents the efficiencies of energy conversion of photo module with solar tracking system and fixed photo module. Tracking system uses 4 photo resistors, which are mounted on the sides of the photo module. By these photo resistors the solar tracking system becomes more sensitive and it allows to determine a more accurate location of the sun and Arduino controller to control circuits to drive two motors used to move the solar panel so that sun's beam is able to remain aligned with the solar panel.

2. ACTUAL DESIGN OF MECHANISM

This project shows maximum power has been generated from the sunlight automatically. This system is tracking for maximum intensity of light. When there is a decrease in intensity of light this system automatically changes its direction to get maximum intensity of light. Development of a dual axis tracking system used light dependent resistor (LDR) as sensor. The resistance of LDR decreases with increasing light intensity. Two motors are used here for rotating the solar panel in two different axes. In this dual axis we are using four LDRs for detecting the light intensity. To track the sun movement accurately a dual axis tracking system is necessary. With the sun always facing the panel, the maximum energy can be absorbed as the panel operates at its greatest efficiency. The main objective of this paper is to get the maximum energy from the sun by accurate tracking of the sun.

Two pairs of light dependent resistors (LDR) are used as sensors to track the sun's exact position. One pair senses the position of the sun in the vertical axis i.e. east and west side and the other pair in the horizontal axis i.e. north and south side. This information is then passed to the light comparison unit. The rest LDR senses the night mode and the signal is sent to the light comparison unit. A light dependent resistor (LDR) is a resistor whose resistance decreases with increasing incident light intensity. Arduino controller is the main control unit of this whole system. The output from the light comparison unit comes to the input of the Arduino controller which determines the direction of the movement of the motors both in the horizontal and vertical axes. Figure 1 shows the practical design of mechanism of dual-axis solar tracking system.

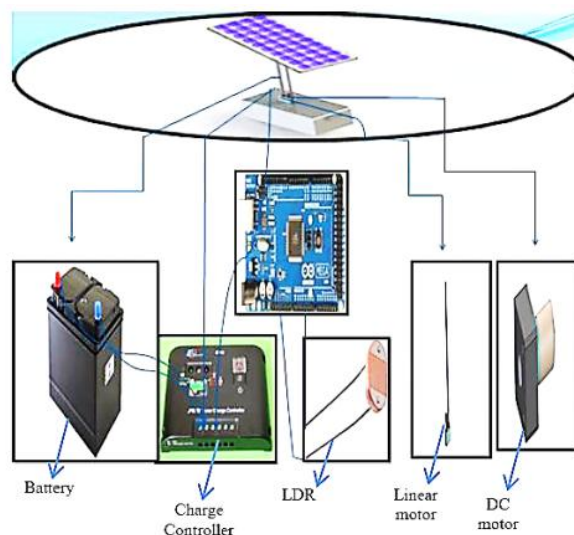

Figure 1 shows the Actual Mechanism of Construction

Also, table 1 shows the components that are used in practical design to implement the dual-axis solar tracking system.

Item	Size or part no.
ARDUINO	ATmega2560
Regulator	7805
Resistor	10k
Resistor	1k
Two Transistor(NPN)	BC 547
Two relay	10 Ampere ,12 Volt
Photo cell 100 watt \pm 10	Cadmium
(linear , DC) motor	5V

Table 1 shows the components that used in practical design

As a results the sun rotational movement relative to the earth also spacing distance between the sun and the earth during the day as the position of the sun relative to the earth varies from time to time during the day so it was necessary to prosecute the system of the sun to take advantage of the maximum amount of sunlight to generate electricity through the programming to control of motors movement of rotation and movement of the top and bottom of the system. Figure 2 shows the circuit to control the movement of the motors.

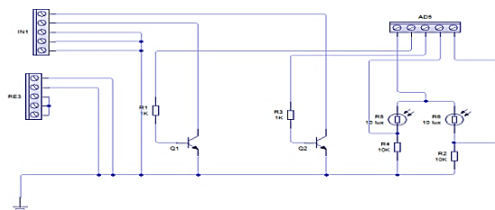

Figure 2, control circuit in motors.

Figure 3 describes the full circuit design

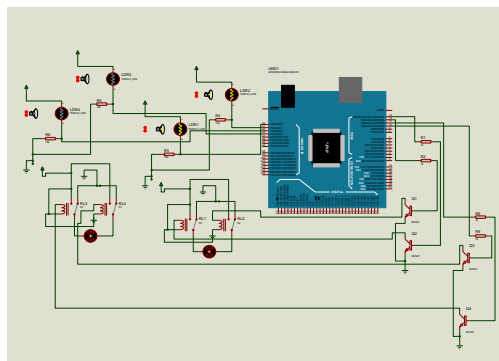

Figure 3, shows the full circuit design.

3. EXPERIMENTAL RESULTS

Results taken in month of May were taken results in three cases:

- A. The first case fixed solar panels the results taken from twelve and a half hours noon until six pm and it even intervals every 15 minutes.
- B. The second case tracking solar panels the results taken from twelve and a half hours noon until five o'clock and forty minutes pm and it even intervals every 10 minutes.
- C. The third case tracking solar panels the results taken from nine and twenty minutes in the morning until twelve and a half hours noon pm and it even intervals every 10 minutes.

For each case we show, i-t, v-t, p-t and p-v characteristics curves which plotted using Matlab.

A. In the Case of Fixed Solar Panel:

In this case the results were taken from twelve and a half hours noon until six pm and it even intervals every 15 minutes were recorded value of each of the electric current, voltage and also power that generated from solar panel.

1- I-T Characteristics of Fixed PV Module

In this case the data recorded for the electric current with time every 15 minutes of time intervals and the data has been plotted using Matlab as shown in figure 4.

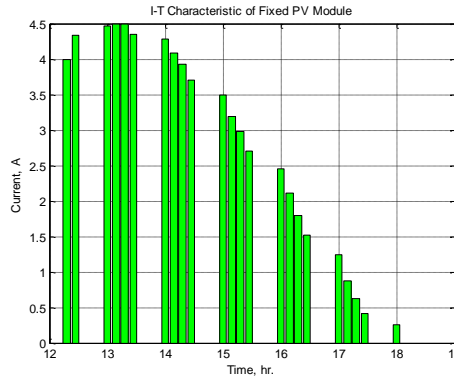

Figure 4, relation between current and time for fixed PV module.

From figure we get the maximum current is 4.5 ampere occurs at time 1:30 PM and the minimum value is 0.26 ampere at 6 PM.

2- V-T Characteristics of Fixed PV Module

In this case the data recorded for the electric voltage with time every 15 minutes of time intervals and the data has been plotted using Matlab as shown in figure 5.

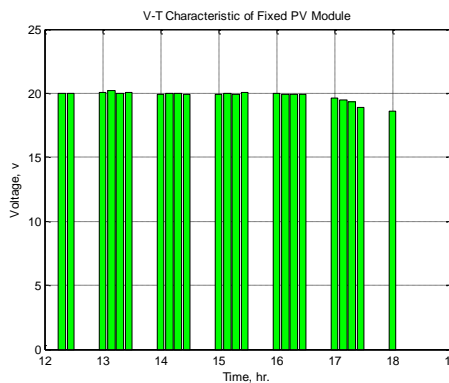

Figure 5, relation between voltage and time for fixed PV module.

In this case the maximum voltage is 20.2 volt occurs at time 1:15 PM and the minimum value is 18.6 volt at 6 PM.

3- P-T Characteristics of Fixed PV Module

In this case the data recorded for the power with time every 15 minutes of time intervals and the data has been plotted using Matlab as shown in figure 6.

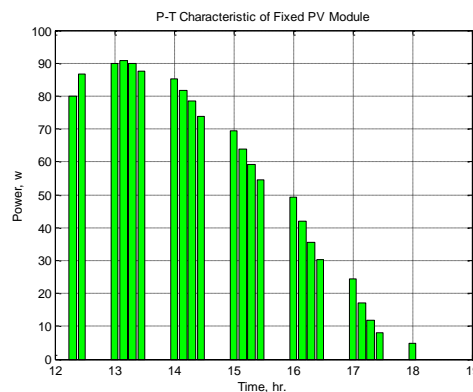

Figure 6, relation between power and time for fixed PV module.

Note from the figure solar panel records maximum capability of electric power in the period from 1:15 to 1:30 PM and also recorded the lowest value in the sixth hour of the night.

4- P-V Characteristics of Fixed PV Module

In this case the data recorded for the power with electric voltage, the data has been plotted using Matlab as shown in figure 7.

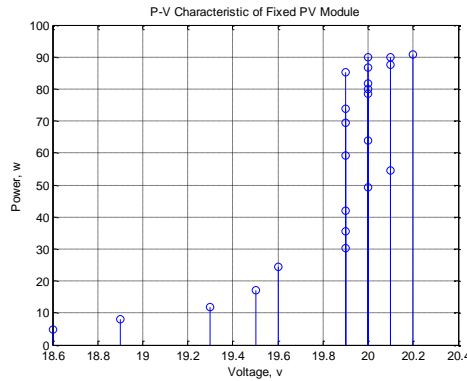

Figure 7, relation between power and voltage for fixed PV module

Note from the figure solar panel records maximum capability of electric power in the period from 1:15 to 1:30 PM and at maximum voltage of 20.2 volt also recorded the lowest value in the sixth hour of the night at minimum value of 18.6 volt as shown in figure 7.

B. In the Case of Tracking Solar Panel:

In this case the results were taken from twelve and a half hours noon until five o'clock and forty minutes pm and it even intervals every 10 minutes were recorded value of each of the electric current, voltage and also power generated from solar panel.

1- I-T Characteristics of Tracking PV Module

In this case the data recorded for the electric current with time every 10 minutes of time intervals and the data has been plotted using Matlab as shown in figure 8.

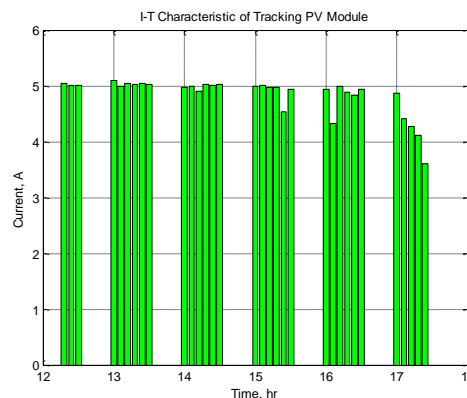

Figure 8, relation between current and time for tracking PV module.

From figure we get the maximum current is 5.09 ampere occurs at time 1:00 PM and the minimum value is 3.6 ampere at 5:40 PM.

2- V-T Characteristics of Tracking PV Module

In this case the data recorded for the electric voltage with time every 10 minutes of time intervals and the data has been plotted using Matlab as shown in figure 9.

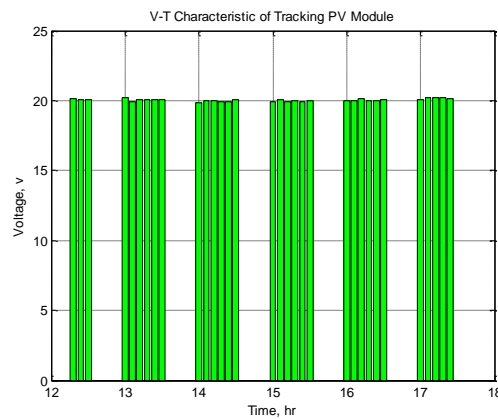

Figure 9, relation between voltage and time for tracking PV module.

In this case the maximum voltage is 20.22 volt occurs at time 1:00 PM and the minimum value is 20.16 volt at 5:40 PM.

3- P-T Characteristics of Tracking PV Module

In this case the data recorded for the power with time every 10 minutes of time intervals and the data has been plotted using Matlab as shown in figure 10.

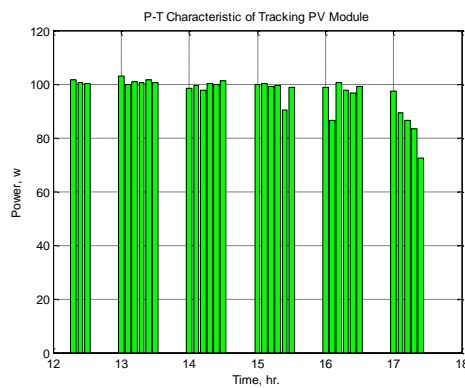

Figure 10, relation between power and time for tracking PV module.

Note from the figure solar panel records maximum capability of electric power in the period from 12:30 to 1:40 PM and also recorded the lowest value in the 5:40 PM of the night.

4- P-V Characteristics of Tracking PV Module

In this case the data recorded for the power with electric voltage, the data has been plotted using Matlab as shown in figure 11.

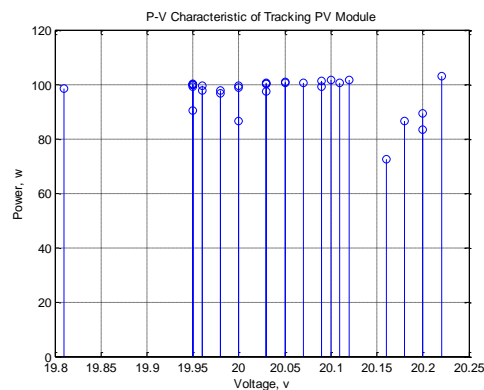

Figure 11, relation between power and voltage for tracking PV module

Note from the figure solar panel records maximum capability of electric power in the period from 12:30 to 1:40 PM and at maximum voltage of 20.22 volt also recorded the lowest value in the 5:40 pm of the night and minimum value of 19.81 volt as shown in figure 7, also shows that the electrical power value increased markedly worth in the case of tracking in the case of fixed.

C. In the Case of Tracking Solar Panel:

In this case the results were taken from nine and twenty minutes in the morning until twelve and a half hours noon pm and it even intervals every 10 minutes were recorded value of each of the electric current, voltage and also power generated from solar panel

1- I-T Characteristics of Tracking PV Module

In this case the data recorded for the electric current with time every 10 minutes of time intervals and the data has been plotted using Matlab as shown in figure 12.

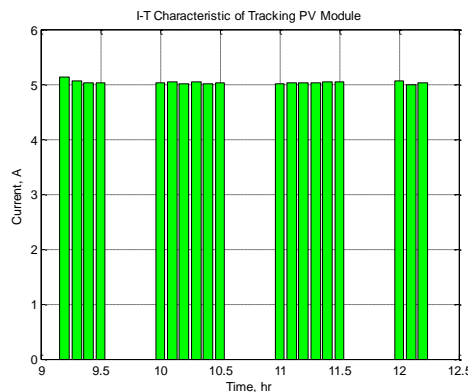

Figure 12, relation between current and time for tracking PV module.

From figure we get the maximum current is 5.13 ampere occurs at time 9:20 AM and the minimum value is 4.99 ampere at 12:20 AM.

2- V-T Characteristics of Tracking PV Module

In this case the data recorded for the electric voltage with time every 10 minutes of time intervals and the data has been plotted using Matlab as shown in figure 13.

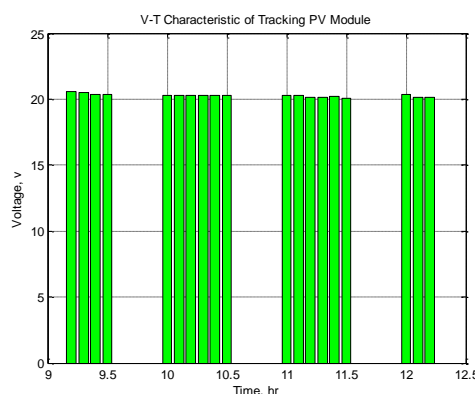

Figure 13, relation between voltage and time for tracking PV module.

In this case the maximum voltage is 20.57 volt occurs at time 9:20 AM and the minimum value is 20.11 volt at 12:10 AM.

3- P-T Characteristics of Tracking PV Module

In this case the data recorded for the power with time every 10 minutes of time intervals and the data has been plotted using Matlab as shown in figure 14.

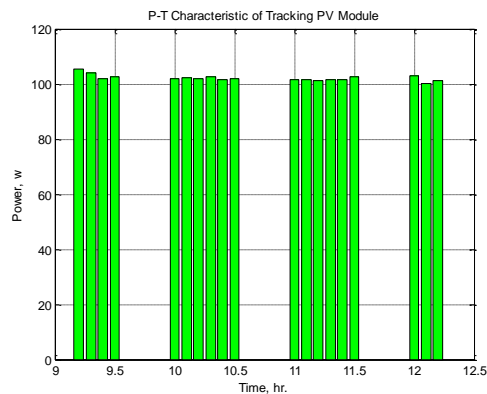

Figure 14, relation between power and time for tracking PV module.

Note from the figure solar panel records maximum capability of electric power in the period from 9:20 to 12:20 AM.

4- P-V Characteristics of Tracking PV Module

In this case the data recorded for the power with electric voltage, the data has been plotted using Matlab as shown in figure 15.

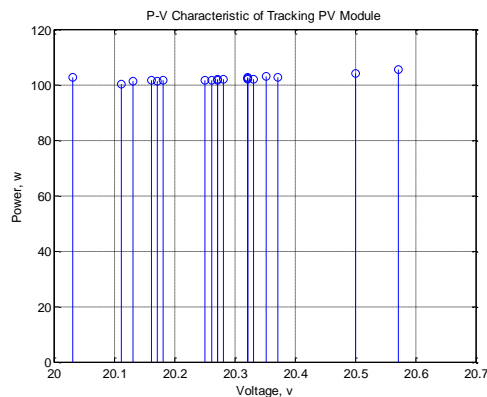

Figure 15, relation between power and voltage for tracking PV module

Note from the figure solar panel records maximum capability of electric power in the period from 9:20 to 12:20 AM and at maximum voltage of 20.57 volt as shown in figure 7, also shows that the electrical power value increased markedly worth in the case of tracking in the case of fixed.

4. CONCLUSIONS

Sun tracking solar system is reliable and mostly used for production of high efficiency in most of the countries. This paper explains solar tracking system through the use of Arduino controller, which also shows the solution software appropriate for increasing the yield of solar systems to the greatest value through the system guide to solar radiation great point, and then return to the status primitive after sunset for a new day. As a result of the lack of efficiency of electricity generation from fixed solar cells, so this paper have resorted to the method of tracking the sun for maximum ability of solar energy through the use of motors to control and move the solar panels to track down the sun. After studied this work we have got the maximum energy from the sun and make the system eco-friendly with the environment. The maximum energy from the sun obtained by move the panel in correct direction with correct angle and makes the panel perpendicular to the sun. The effectiveness of the Sun tracker is confirmed experimentally. And the output has been plotted into a graph and has been analyzed. The results showed that the dual-axis solar tracking system is highly efficient in terms of electrical energy output when compared with fixed solar system.

REFERENCES

- [1] Ahmad Mohammed Sinjari and Sarkar Jawhar Mohammed Shareef, "Dual Axis Solar Tracking System Using PLC", 1st International Conference on Engineering and Innovative Technology, SU- ICEIT, April 12- 14, 2016.
- [2] T.S.Y. Moh and E.M.S. Ting, "Efficiency Improvement Based on Cooling Effect via Immersion Technique in a PV Solar Panel: Tropical and Cloudy Weather Setting", International Journal of Innovative Research in Electrical, Electronics, Instrumentation and Control Engineering, vol. 4, Issue 10, pp. 1-6, October 2016.
- [3] K. Vijayalakshmi, B. Narendra and K. S. R Anjaneyulu, "DESIGNING A DUAL AXIS SOLAR TRACKING SYSTEM FOR MAXIMUM POWER", INTERNATIONAL JOURNAL OF ENGINEERING SCIENCES & RESEARCH TECHNOLOGY, vol. 5, no.8, pp.286-290, August, 2016.



- [4] Jing-Min Wang and Chia-Liang Lu, "Design and Implementation of a Sun Tracker with a Dual-Axis Single Motor for an Optical Sensor-Based Photovoltaic System", *Sensors*, vol. 13, pp. 3157-3168, 2013.
- [5] A. Salam Al-Ammri, Falah I. Mustafa Al-Attar and Farouk F. Ahmad, "Performance Test of Two-Axis Solar Tracker System with Distinct Tracking Strategies", *AASCIT Journal of Energy*, vol. 2, no. 5, pp. 57-60, 2015.
- [6] Deepthi.S, Ponni.A, Ranjitha.R and R Dhanabal, "Comparison of Efficiencies of Single-Axis Tracking System and Dual-Axis Tracking System with Fixed Mount", *International Journal of Engineering Science and Innovative Technology (IJESIT)*, vol. 2, Issue 2, pp. 425-430, March 2013.
- [7] Dhanalakshmi.V, Lakshmi Prasanna.H.N and Priyanka.V, "Dual Axis Solar Tracker Using Arduino Uno", *International Journal on Recent and Innovation Trends in Computing and Communication*, vol. 4, Issue 6, pp. 386 – 388, 2016.
- [8] Nader Barsoum, Rinoe Nizam and Elvin Gerard, "New Approach on Development a Dual Axis Solar Tracking Prototype", *Wireless Engineering and Technology*, vol. 7, pp. 1-11, 2016.
- [9] S. Ozcelik, H. Prakash and R. Chaloo, "Two-Axis Solar Tracker Analysis and Control for Maximum Power Generation", vol. 6, pp. 457-462, *Procedia Computer Science*, 2011.
- [10] PRIYANKA MANE and AKSHAY DHUMAL, "DUAL AXIS SOLAR TRACKING SYSTEM COMPARATIVE STUDY AND MECHANICAL DESIGN IMPLEMENTATION", *Proceedings of 54th IRF International Conference*, Pune, India, pp. 1-4, 8th May, 2016.
- [11] Neenu Sharma and Brijbhushan Sharma, "An Analysis of Automatic Dual Axis Sun Tracking Solar System", *International Journal of Innovative Research in Electrical, Electronics, Instrumentation and Control Engineering*, vol. 4, Issue 12, pp. 45-47, December 2016.
- [12] Fathy M. Mustafa, " DUAL-AXIS SOLAR TRACKING OVER FIXED SOLAR SYSTEMS", *International Journal of Advances in Engineering & Technology*, vol. 9, Issue 5, pp. 563-568, Oct., 2016.

Fathy M. Mustafa: received the B.Sc. degree in Electronics and communications department from the Faculty of Engineering, Fayoum University, Fayoum, Egypt, in 2003. He is earned the M.Sc degree in Electronics and communication engineering in 2007 from Arab Academy for Science and Technology & Maritime Transport College of Engineering and Technology, Alexandria, Egypt. He received his Ph.D in electrical engineering from Mina University in 2013. Her areas of interest include optical communications, optical amplifiers and solar cells.

Seif A. Ahmed: Mechanical Engineering Department Faculty of Engineering, Beni-Suef University, Beni Suef, Egypt.