



# Evaluation of Bridge Performance Using Non-Destructive Testing - A Review

Ayswarya K.S<sup>1</sup>, Ann Maria Johnson<sup>2</sup>, Chaithanya<sup>3</sup>, Devika Prasad<sup>4</sup>, Dhanya Krishnan R<sup>5</sup>, Radhika Nair N J<sup>6</sup>

Student –B.tech, Civil Engineering Department, LBS Institute of Technology for Women, India<sup>1,2,3,4,5</sup>

Assistant Professor – Civil Engineering Department, LBS Institute of Technology for Women, India<sup>6</sup>

**Abstract:** Civil infrastructure systems such as highways, bridges, buildings represent the skeleton of any nation. The deterioration of bridges in many countries in the last few decades calls for effective methods for condition evaluation and maintenance. Since there is increasing dependency of the society on infrastructure systems such as bridges, proper design and timely monitoring and maintenance is essential. However, various factors such as neglect, overuse and lack of proper inspection and monitoring has led to accelerated deterioration of bridges. Often, unsatisfactory inspection and monitoring leads to detection of damage only at the critical state where repair cost becomes comparable with replacement cost. Assessing the extent of damage and its speedy restoration essentially requires information about the current and previous states of health of the structure. Hence there is a need for continuous monitoring of the health of the structure. This has resulted in the development of several non-destructive testing (NDT) techniques for monitoring their performance. The concept of non destructive testing (NDT) is to obtain material properties of in place specimens without the destruction of the specimen or the structure from which it is taken. It can provide knowledge that may not be possible to deduce from visual observation alone. Successful NDT tests allow locating and characterizing material conditions which might not be visible on the surface but which affects the structural durability or performance. This paper reviews various NDT methods that are currently being used in conjunction with the condition assessment of bridge component when subject to cracking, fracture and other unseen damage cases, specifically focusing on Rebound hammer Test and ultrasonic pulse velocity Test. Also this paper reviews three case studies conducted in India, Malaysia and Turkey. The case study from India determines the quality and strength of a T-beam girder bridge. 75 concrete bridges under the supervision of Public Works Department, Malaysia and 10 out of 200 reinforced concrete bridges (i.e. 10 most deficient bridges) in Turkey were selected to determine the strength and to establish a correlation between visual inspection rating and the non-destructive testing results. The investigation shows that the use of non-destructive testing methods can help reduce the backlog of deficient bridges in two ways. First, these techniques will allow inspectors to get a more accurate view of the condition of a bridge. The second way is by allowing inspectors to locate damages earlier. The studies also show that Ultrasonic pulse velocity Test is the ideal NDT method to predict the deterioration in the structures and to determine the service life of the structures. And there exists a correlation between results of non-destructive tests and condition states based on visual inspections.

**Keywords:** non-destructive testing, rebound hammer test, Ultrasonic Pulse velocity method, Case Studies.

## I. INTRODUCTION

It is often necessary to test concrete structures after the concrete has hardened to determine whether the structure is suitable for its designed use. Ideally such testing should be done without damaging the concrete. Non-Destructive Testing (NDT) is a method used to determine the condition and quality of concrete or to locate objects embedded in concrete, without damaging or destroying the concrete. Non-Destructive Testing (NDT) is defined by the American Society for Non-destructive Testing (ASNT) as: “The determination of the physical condition of an object without affecting that object’s ability to fulfil its intended function”. Bridges and other structures deteriorate with time and use. The deterioration process is affected by several characteristics: traffic, rain, freeze, thaw cycles, climate, pollution, temperature, and moisture variations. This deterioration process can lead to eventual failure of the bridge. Periodic bridge inspections are therefore necessary to assess the extension, implications, and current state of the deterioration process. Currently, bridges are evaluated through either a visual inspection or structural analysis. Visual inspections are commonly used nowadays. When bridge evaluation is conducted using this method, a subjective rating will be assigned to the bridge components by the responsible inspector. Visual inspection provides no useful information until visible defects starts to appear in the structural members. Damages inside the structure that are not visible are difficult to identify. The application of the non-destructive testing method in bridge inspections has gained interests among researchers due to its effective ability in evaluating structural condition of the bridge.



The various common NDT methods used are Visual and optical Testing, Electromagnetic Testing, Infrared Thermographic testing, Radiography Testing, Impact echo, Rebound Hammer Testing, Ultrasonic Pulse Velocity Testing. Visual inspection is particularly effective detecting macroscopic flaws, such as poor welds.

Many welding flaws are macroscopic like crater cracking, undercutting, slag inclusion, incomplete penetration welds etc. Electromagnetic Testing (ET), as a form of NDT, is the process of inducing electric currents or magnetic fields or both inside a test object and observing the electromagnetic response. Infrared Thermography is the science of measuring and mapping surface temperatures. Radiographic methods for concrete inspection include gamma-ray radiography, X-ray radiography, and X-ray radioscopy. A radiographic image is taken through a concrete component to reveal a picture of the interior. Radiography is a reliable method to “see through” a concrete component, and can detect interior flaws. The impact-echo technique is based on generating a short duration impact (sound) wave onto the test surface. These waves propagate into the concrete and are reflected by the opposite face of the concrete, or from internal flaws or other objects and the signals received are analysed to determine the existence and depth of defects. Rebound hammer testing and ultrasonic pulse velocity methods are discussed in detail in this paper.

## II. REBOUND HAMMER TESTING

The rebound hammer (such as the Schmidt Hammer) is a simple, handy tool which is used to measure the hardness and predict the strength of the concrete. This is a spring-loaded impacting device that incorporates a scale to measure the energy of the rebound following the impact. The extent of rebound gives an indication of the strength of the concrete at the surface position tested.

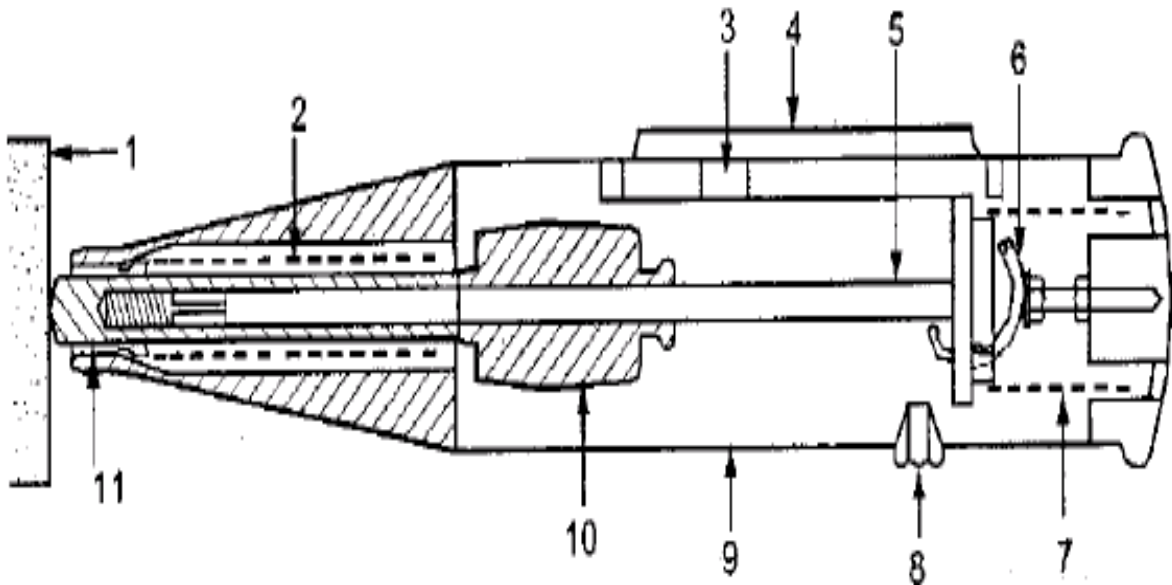

1. Concrete surface; 2. Impact spring; 3. Rider on guide rod; 4. Window and scale; 5. Hammer guide; 6. Release catch; 7. Compressive spring; 8. Locking button; 9. Housing; 10. Hammer mass; 11. Plunger

Fig 1: Components of a Rebound Hammer

(Source- Guidelines on Non-Destructive Testing of Bridges, August, 2009, Government of India)

### A. Objective:

The rebound hammer method could be used for –

- Assessing the likely compressive strength of concrete with the help of suitable co-relations between rebound index and compressive strength.
- Assessing the uniformity of concrete.
- Assessing the quality of concrete in relation to standard requirements.
- Assessing the quality of one element of concrete in relation to another.

### B. Principle:

The method is based on the principle that the rebound of an elastic mass depends on the hardness of the surface against which mass strikes. When the plunger of rebound hammer is pressed against the surface of the concrete, the spring controlled mass rebounds and the extent of such rebound depends upon the surface hardness of concrete.

The surface hardness and therefore the rebound are taken to be related to the compressive strength of the concrete. The rebound value is read off along a graduated scale and is designated as the rebound number or rebound index. The compressive strength can be read directly from the graph provided on the body of the hammer.

TABLE I: The impact energy required for rebound hammer for different applications  
(Source- Guidelines on Non-Destructive Testing of Bridges, August, 2009, Government of India)

Sr. No.	Application	Approximate impact energy required for the rebound hammers (N-m)
1	For testing normal weight concrete	2.25
2	For light weight concrete or small and impact sensitive part of concrete	0.75
3	For testing mass concrete i.e. in roads, airfield pavements and hydraulic structures	30.00

C. Methodology:

Prior to testing, the rebound hammer should be calibrated using a calibration test anvil supplied by the manufacturer for that purpose. The testing anvil should be of steel having Brinell hardness number of about 5000.

For taking a measurement, the hammer should be held at right angles to the surface of the structure. The test thus can be conducted horizontally on vertical surface and vertically upwards or downwards on horizontal surfaces.

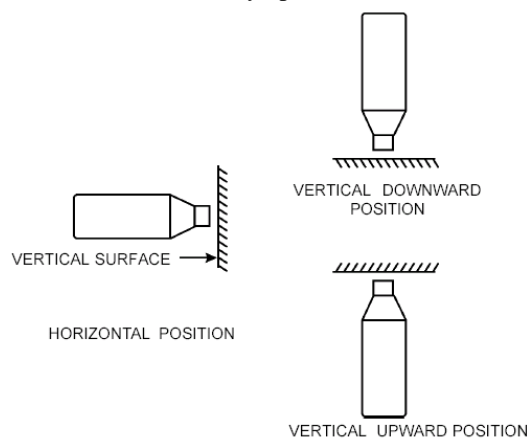

Fig 4: Various positions of Rebound Hammer

(Source- Ayaz Mahmood, “Structural Health Monitoring Using Non Destructive Testing Of Concrete”, 2008)

If the situation demands, the hammer can be held at intermediate angles also. The average of about 10 to 20 impacts would give an approximate indication as to the compressive strength of concrete at that location. The device is sensitive to a number of factors such as the surface finish, striking aggregate or mortar, the age, the moisture content and hardness, and these factors can influence the predicted strength concrete.

Correlations of rebound number should be developed where possible with the compressive strength of concrete. The most satisfactory way of establishing a correlation between compressive strength of concrete and its rebound number is to measure both the properties simultaneously on concrete cubes. The concrete cubes specimens are held in a



compression testing machine under a fixed load, measurements of rebound number taken and then the compressive strength determined as per IS 516: 1959. The fixed load required is of the order of 7 N/ mm<sup>2</sup> when the impact energy of the hammer is about 2.2 Nm. The load should be increased for calibrating rebound hammers of greater impact energy and decreased for calibrating rebound hammers of lesser impact energy. Only the vertical faces of the cubes as cast should be tested. At least nine readings should be taken on each of the two vertical faces accessible in the compression testing machine when using the rebound hammers.

#### D. Interpretation of results:

After obtaining the correlation between compressive strength and rebound number, the strength of structure can be assessed. In general, the rebound number increases as the strength increases and is also affected by a number of parameters i.e. type of cement, type of aggregate, surface condition and moisture content of the concrete, curing and age of concrete, carbonation of concrete surface etc. Moreover the rebound index is indicative of compressive strength of concrete up to a limited depth from the surface. The internal cracks, flaws etc. or heterogeneity across the cross section will not be indicated by rebound numbers.

As such the estimation of strength of concrete by rebound hammer method cannot be held to be very accurate and probable accuracy of prediction of concrete strength in a structure is  $\pm 25$  percent.

### III. ULTRASONIC PULSE VELOCITY TESTER

Ultrasonic instrument is a handy, battery operated and portable instrument used for assessing elastic properties or concrete quality. The apparatus for ultrasonic pulse velocity measurement consists of the following–

(a) Electrical pulse generator (b) Transducer – one pair (c) Amplifier (d) Electronic timing device



Fig 5: Apparatus for UPV measurement

(Source- Guidelines on Non-Destructive Testing of Bridges, August, 2009, Government of India)

#### A. Object:

The ultrasonic pulse velocity method could be used to establish:

- (a) The homogeneity of the concrete
- (b) The presence of cracks, voids and other imperfections
- (c) Change in the structure of the concrete which may occur with time
- (e) The quality of one element of concrete in relation to another
- (f) The values of dynamic elastic modulus of the concrete.

#### B. Principle:

The method is based on the principle that the velocity of an ultrasonic pulse through any material depends upon the density, modulus of elasticity and Poisson's ratio of the material. Comparatively higher velocity is obtained when concrete quality is good in terms of density, uniformity, homogeneity etc. The ultrasonic pulse is generated by an electro acoustical transducer. When the pulse is induced into the concrete from a transducer, it undergoes multiple reflections at the boundaries of the different material phases within the concrete. A system of waves is developed and the receiving transducer detects the onset of longitudinal waves which is the fastest.



The velocity of the pulses is almost independent of the geometry of the material through which they pass and depends only on its elastic properties. Pulse velocity method is a convenient technique for investigating structural concrete.

For good quality concrete pulse velocity will be higher and for poor quality it will be less. If there is a crack, void or flaw inside the concrete which comes in the way of transmission of the pulses, the pulse strength is attenuated and it passed around the discontinuity, thereby making the path length longer. The actual pulse velocity obtained depends primarily upon the materials and mix proportions of concrete. Density and modulus of elasticity of aggregate also significantly affects the pulse velocity.

Any suitable type of transducer operating within the frequency range of 20 KHz to 150 KHz may be used. Piezoelectric and magneto-strictive types of transducers may be used. The electronic timing device should be capable of measuring the time interval elapsing between the onset of a pulse generated at the transmitting transducer and onset of its arrival at receiving transducer. Two forms of the electronic timing apparatus are possible, one of which use a cathode ray tube on which the leading edge of the pulse is displayed in relation to the suitable time scale, the other uses an interval timer with a direct reading digital display.

### C. Methodology:

The equipment should be calibrated before starting the observation and at the end of test to ensure accuracy of the measurement and performance of the equipment. It is done by measuring transit time on a standard calibration rod supplied along with the equipment. To start with the location of measurement should be marked and numbered prior to actual measurement. There should be adequate acoustical coupling between concrete and the face of each transducer to ensure that the ultrasonic pulses generated at the transmitting transducer should be able to pass into the concrete and detected by the receiving transducer with minimum losses. It is important to ensure that the layer of smoothing medium should be as thin as possible. Couplant like petroleum jelly, grease, soft soap and glycerol paste are used as a coupling medium between transducer and concrete. Special transducers have been developed which impart the pulse through integral probes tips. A receiving transducer with a hemispherical tip has been found to be very successful. Most of the concrete surfaces are sufficiently smooth. Uneven or rough surfaces should be smoothed using carborundum stone before placing of transducers. Alternatively, a smoothing medium can also be used, but good adhesion between concrete surface and smoothing medium has to be ensured so that the pulse is propagated with minimum losses into the concrete.

Transducers are then pressed against the concrete surface and held manually. It is important that only a very thin layer of coupling medium separates the surface of the concrete from its contacting transducer. The distance between the measuring points should be accurately measured. Repeated readings of the transit time should be observed.

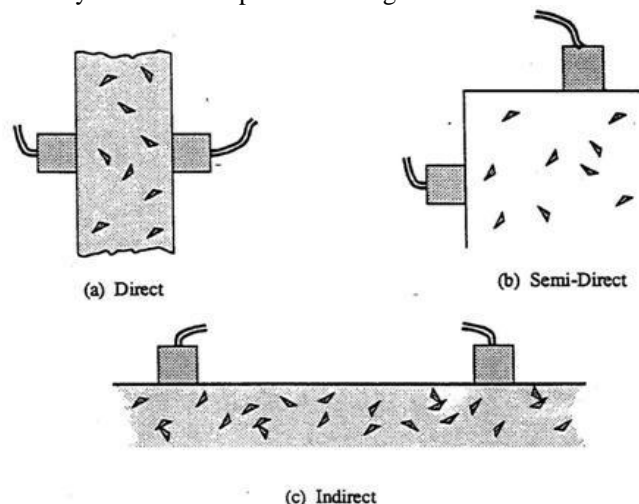

Fig 6: Various Methods of UPV Testing

(Source- Ayaz Mahmood, "Structural Health Monitoring Using Non Destructive Testing Of Concrete", 2008)

Once the ultrasonic pulse impinges on the surface of the material, the maximum energy is propagated at right angle to the face of the transmitting transducers and best results are, therefore, obtained when the receiving transducer is placed on the opposite face of the concrete member known as Direct Transmission. The pulse velocity can be measured by





Direct Transmission, Semi-direct Transmission and Indirect or Surface Transmission. Normally, Direct Transmission is preferred being more reliable and standardized. Figure 6 shows the various types of UPV testing.

#### Determination of pulse velocity

A pulse of longitudinal vibration is produced by an electro acoustical transducer, which is held in contact with one surface of the concrete member under test. After traversing a known path length (L) in the concrete, the pulse of vibration is converted into an electrical signal by a second electro-acoustical transducer and electronic timing circuit enable the transit time (T) of the pulse to be measured. The pulse velocity (V) is given by:

$$V = L / T$$

Where, V = Pulse velocity, L = Path length, T = Time taken by the pulse to traverse the path length.

#### D. Interpretation of Results:

The ultrasonic pulse velocity of concrete can be related to its density and modulus of elasticity. It depends upon the materials and mix proportions used in making concrete as well as the method of placing, compacting and curing of concrete. If the concrete is not compacted thoroughly and having segregation, cracks or flaws, the pulse velocity will be lower as compare to good concrete, although the same materials and mix proportions are used. The quality of concrete in terms of uniformity can be assessed using the guidelines given in table 2:

If details of material and mix proportions adopted in the particular structure are available, then estimate of concrete strength can be made by establishing suitable correlation between the pulse velocity and the compressive strength of concrete specimens made with such material and mix proportions. The estimated strength may vary from the actual strength by  $\pm 20$  percent. The correlation so obtained may not be applicable for concrete of another grade or made with different types of material

TABLE II: Criterion for Concrete Quality Grading (As per IS 13311(Part 1): 1992)  
(Source- Guidelines on Non-Destructive Testing of Bridges, August, 2009, Government of India)

Sr. No.	Pulse velocity (km/sec.)	Concrete quality grading
1	Above 4.5	Excellent
2	3.5 to 4.5	Good
3	3.0 to 3.5	Medium
4	Below 3.0	Doubtful

**Note:** in case of doubtful quality, it will be desirable to carry out further tests

#### IV. USE OF NDT IN EVALUATION OF BRIDGE PERFORMANCE

The transportation infrastructure is deteriorating rapidly due to age, increased traffic demands, and lack of funding for repairs. The need for efficient, accurate, and cost effective inspection and evaluation methods is more important than ever. Bridge structures require periodic inspection in order to detect structural flaws and safety hazards, as well as to determine the maintenance and repair needs. Usually a common method used is visual inspection. And the maintenance programs are prepared based on the results of these inspections. But this method identifies only those damages which become visible. This indicates that there is an ample demand for test methods to establish the condition of structures before heavy damage has occurred. For regular inspections, non-destructive test methods (NDT) may provide a relatively quick and inexpensive means to establish whether a structure is still in a serviceable condition or not. Results of these investigations improve the quality of information. Also non-destructive testing is particularly useful for evaluating in-service bridges, since the bridges can remain intact and open to traffic during the inspection and evaluation period, that is it has minimal the impact on the community and the travelling public. Here we consider three case studies, where NDT methods were used to monitor the bridges.

##### A. Evaluation of T-beam girder bridge, India

The assessment of quality and strength of a T-beam girder bridge, constructed across a river in India was carried out by correlating the NDT observations with core tests. The assessment involved the core tests, Rebound hammer tests and Ultrasonic pulse velocity tests. It was reported that the strength of concrete in one of the piers could not be achieved by the testing of corresponding concrete cubes. Further the core samples collected gave different strength values. In this



connection it was recommended to have the grouting of the pier. After the grouting carried out in accordance with required procedure the Non destructive test was carried-out using Rebound hammer and Ultrasonic pulse velocity tester. Further to quantify the strength of concrete three core samples were also collected for testing.

Cores are usually extracted by drilling using a diamond tipped core cutter cooled with water. The selection of the locations for extraction of core samples is made after non-destructive testing which can give guidance on the most suitable sampling areas. Moreover, using non-destructive tests, the number of cores that need to be taken can be reduced or minimized. This is often an advantage since coring is frequently viewed as being destructive. The testing was conducted in the presence of concerned Engineering personnel. The diameter and height of the pier is 1.8m and 3.35 m measured from base to the bottom of the pier cap, respectively. For testing the pier, a grid of 0.71 m x 0.8 m has been marked .The core samples for conducting the destructive test were collected from three locations (1C, 3D and 5D). The test results are presented in Table 3-5.

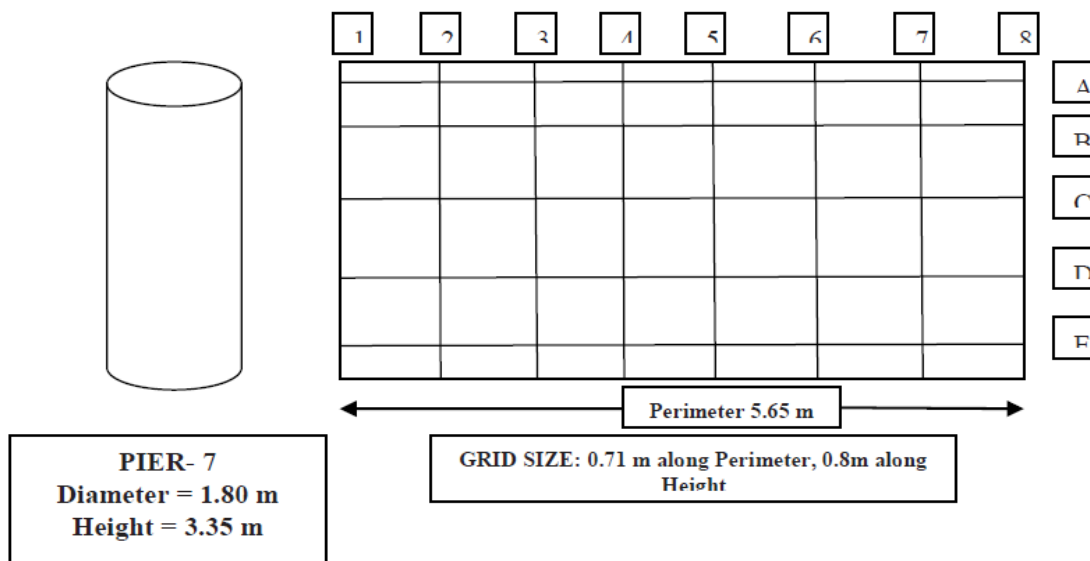

Fig 7 : Grid Points marked on the Pier

(Source- D.R. Seshu and N.R.D. Murthy / Procedia Engineering 54 (2013) 564 – 572)



Fig 8 : Testing of Bridge Pier using Rebound Hammer



Fig 9: Testing of Bridge Pier using Ultrasonic Tester

(Source- D.R. Seshu and N.R.D. Murthy / Procedia Engineering 54 (2013) 564 – 572)



Fig 10 : Extraction of Concrete core from the Bridge Pier

(Source- D.R. Seshu and N.R.D. Murthy / Procedia Engineering 54 (2013) 564 – 572)

The Concrete Core test results indicated that the Average Compressive Strength of Concrete is 32.91MPa. Also it is observed that individual core test values (which are within  $\pm 20\%$  of average value) are above 20MPa and satisfy the strength requirement of M20 grade concrete. The average Ultrasonic Pulse velocity obtained is 3.942km/sec. Further none of the USP value is less than 3km/sec. Also the variation in individual USP values is within  $\pm 10\%$  of average. This indicated, as per the guidelines laid in IS-13311-Part 1- 1992, that the quality of concrete in terms of uniformity, incidence or absence of flaws, cracks and segregation, the level of workmanship employed may be categorized as 'Medium'

The Average Rebound value is 34.58 and the variation in individual values is within  $\pm 10\%$ . The Concrete compressive strength as interpreted from the rebound value is 24.865 MPa, which satisfies the requirement of M20 grade concrete.

TABLE III. Concrete core test results

(Source- D.R. Seshu and N.R.D. Murthy / Procedia Engineering 54 (2013) 564 – 572)

Core No.	Dia. (mm)	Cross Sectional Area (Sq.mm)	Height (mm)	Rebound Values	Average Rebound Value	UST ( $\mu$ s)	USP Velocity km/Sec (4)/(7)	Measured Ultimate load In Compression (KN)	Compressive Strength (MPa)	Equivalent Comp. Strength of Concrete Cube (MPa)
(1)	(2)	(3)	(4)	(5)	(6)	(7)	(8)	(9)	(10)	(11)
1C	143	16060.61	288	42,48,46	45.33	65	4.43	500	31.132	38.983
5D	144	16286.02	295	40,44,46	43.33	67	4.40	380	22.911	28.809
3D	142	15836.77	290	50,48,48	48.67	58	5.00	390	24.626	30.942
Average					45.77	--	4.61	--	--	32.911

Note:  $\mu$ s = Micro Seconds

Average Compressive Strength of Concrete is 32.91MPa.



TABLE IV: Ultrasonic pulse velocity test results  
Diameter of the Pier-7 = 1.8 m, Height of Pier = 3.35 m (from Base to the Cap bottom)

(Source- D.R. Seshu and N.R.D. Murthy / Procedia Engineering 54 (2013) 564 – 572)

Wave Path.	Length (mm)	UST (µs)	USP Velocity (km/Sec)	Wave Path.	Length (mm)	UST (µs)	USP Velocity (km/Sec)	Wave Path.	Length (mm)	UST (µs)	USP Velocity (km/Sec)
1A-2A	688	210	3.28	1C-2C	688	220	3.13	1E-2E	688	161	4.27
1A-3A	1273	295	4.32	1C-3C	1273	421	3.02	1E-3E	1273	270	4.71
1A-4A	1663	545	3.05	1C-4C	1663	548	3.03	1E-4E	1663	421	3.95
1A-5A	1800	462	3.90	1C-5C	1800	589	3.06	1E-5E	1800	383	4.70
1A-6A	1663	550	3.02	1C-6C	1663	383	4.34	1E-6E	1663	360	4.62
1A-7A	1273	287	4.44	1C-7C	1273	422	3.02	1E-7E	1273	415	3.07
1A-8A	688	201	3.42	1C-8C	688	144	4.78	1E-8E	688	222	3.10
Ave.USP@ A Level			3.63	Ave.USP@ C Level			3.48	Ave.USP@ E Level			4.06
1B-2B	688	148	4.65	1D-2D	688	223	3.09				
1B-3B	1273	268	4.75	1D-3D	1273	289	4.40				
1B-4B	1663	350	4.75	1D-4D	1663	386	4.31	Ave.USP Velocity =		3.942	km/Sec
1B-5B	1800	371	4.85	1D-5D	1800	419	4.30				
1B-6B	1663	347	4.79	1D-6D	1663	391	4.25				
1B-7B	1273	266	4.79	1D-7D	1273	418	3.05				
1B-8B	688	146	4.71	1D-8D	688	223	3.09				
Ave.USP@ B Level			4.76	Ave.USP@ D Level			3.78				

Average Ultrasonic Pulse (USP) Velocity= (3.63 + 4.76 + 3.48 + 3.78 + 4.06) / 5 = 3.942 km/Se

TABLE V: Rebound hammer test results  
(Source- D.R. Seshu and N.R.D. Murthy / Procedia Engineering 54 (2013) 564 – 572)

Location	Rebound Values	Average Rebound Value	Location	Rebound Values	Average Rebound Value	Location	Rebound Values	Average Rebound Value
1A	29,26,24	26.3	4A	36,36,30	34.0	7A	30,30,26	28.7
1B	46,46,46	46.0	4B	46,36,36	39.3	7B	28,36,30	31.3
1C	42,40,38	40.0	4C	30,34,36	33.3	7C	36,32,42	36.7
1D	42,44,44	42.3	4D	32,28,32	30.7	7D	38,36,36	36.7
1E	50,30,30	36.7	4E	34,36,34	34.7	7E	38,38,30	35.3
		38.26			34.40			33.74
2A	30,28,30	29.3	5A	38,26,30	31.3	8A	30,30,30	30.0
2B	34,40,34	36.0	5B	28,26,28	27.3	8B	40,44,38	40.7
2C	34,36,32	34.0	5C	40,40,34	38.0	8C	34,28,38	33.3
2D	42,36,30	36.0	5D	32,36,34	34.0	8D	38,28,28	31.3
2E	38,30,36	34.7	5E	40,40,26	35.3	8E	40,40,44	41.3
		34.00			33.18			35.32
3A	30,30,32	30.7	6A	28,28,28	28.0			
3B	44,44,44	44.0	6B	40,28,36	34.7			
3C	38,34,32	34.7	6C	28,28,38	31.3			
3D	40,40,38	39.3	6D	26,38,34	32.7			
3E	30,30,36	32.0	6E	30,30,34	31.3			
		36.14			31.6			

Combined Average Rebound Value= (38.26 + 34.00 + 36.14 + 34.40 + 33.18 + 31.60 + 33.74 + 35.32)/8 = 34.58

B. Evaluation of performance of concrete bridges in Malaysia

In this study, concrete bridges on the federal highway in Johor state (Malaysia) were chosen as research samples. 75 concrete bridges from various samples are chosen for the testing. Full tests are carried out on the bridge deck, pier, and abutment. Findings from this testing were then correlated indirectly with the overall strength of the bridges. Figure 11 shows the distribution of bridge samples used in the research. Based on interspan relationship, bridge sample are divided in two main types; simply supported and continuous bridge. Deck type for the selected bridge sample are categorized in two groups; precast (I-beam and inverted T-beam) and cast-in-situ (RC beam and RC slab).

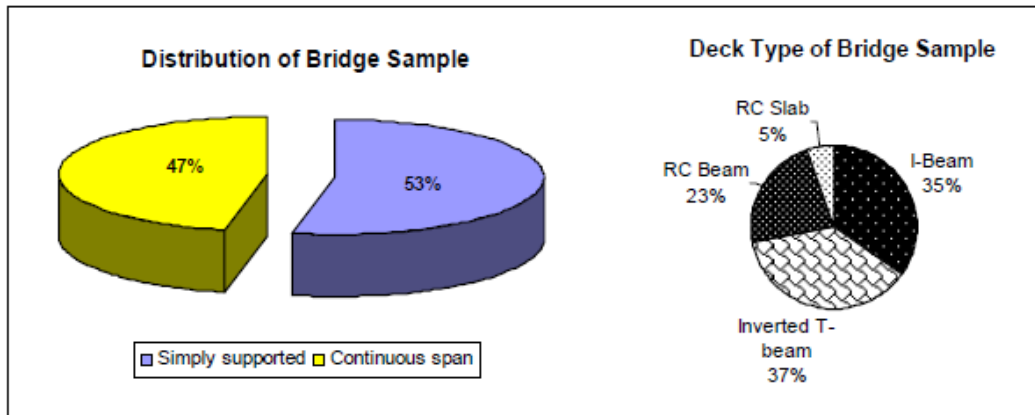

Fig 11: Distribution of bridge samples

(Source- Azlan Adnan, Sophia C. Ali, Karim Mirasa, (APSEC 2006), 5 – 6 September 2006, Malaysia)

Method used in the research is the application of Rebound hammer test based on the standard specification outlined in British Standard BS 1881: Part 202. Rebound Hammer Type N with impact energy = 0.225mkg was used in this research. Smooth and clean surface were selected prior to the testing since rough surface will not give reliable results. 12 readings were taken to estimate surface hardness at each location. Readings were confined to an area not exceeding 300mm x 300mm. A regular grid of lines approximately 50mm apart were drawn on the sample and readings were taken on the intersection of the lines as shown in Figure 12. The mean rebound number obtained in this research is likely to be accurate within  $\pm 4.3\%$  with 95% confidence. To take readings, the plunger of the Rebound hammer is pressed strongly against the concrete surface under test. An impact was caused, and while the hammer is still in position, the index is taken to the nearest whole number. The mean of each set of readings was then calculated using all the readings.

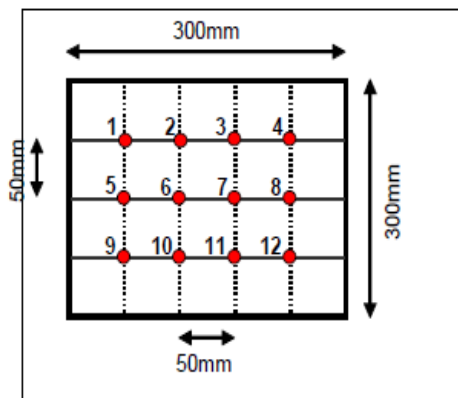

Fig 12: Readings on each location sample



Fig 13: Rebound hammer test conducted on selected abutment

(Source- Azlan Adnan, Sophia C. Ali, Karim Mirasa, (APSEC 2006), 5 – 6 September 2006, Malaysia)

For cast-in-situ deck type; RC beam, the Rebound numbers are 15 to 50 on the hammer scale, with an average of about 36 and a deviation of  $\pm 6.4$ , while for RC slab; it ranges from 26 to 60, with average of 42 and a deviation of  $\pm 5.92$ . It shows the concrete quality is very non uniform. As for precast deck type, Rebound numbers are 41 to 55 for I-beam and 31 to 55 for inverted T-beam with average of 49 and 46 respectively. Deviation is equal to  $\pm 3.16$  for I beam and  $\pm 4.83$  for inverted T-beam, which also indicates non-uniformity in the concrete quality. Precast deck shows higher Rebound numbers and lower deviation compare to cast-insitu deck type.

Figure 14 shows the concrete strength for simply supported bridge sample plotted against age for deck and abutment. Concrete strength is higher in bridge deck then in the abutment. From the age of 7 years old, the concrete strength starts to decrease with time but it is still within the allowable range. The same behaviour occurs to continuous bridge sample. At the age of 39 years old, the concrete strength has dropped below the 'sound' level. Concrete strength in bridge deck is also higher compared to the pier as shown in Figure 15.

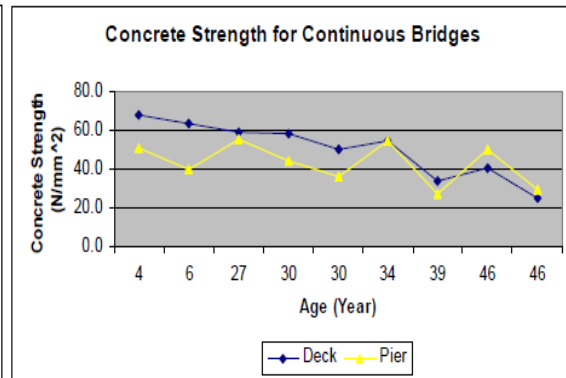
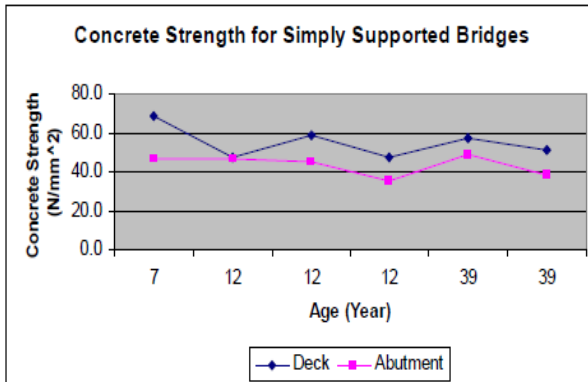

Fig 14: Concrete strength in simply supported bridge sample Fig 15: Concrete strength in continuous bridge sample

(Source- Azlan Adnan, Sophia C. Ali, Karim Mirasa, (APSEC 2006), 5 – 6 September 2006, Malaysia)

Concrete strength obtained from Rebound hammer test are then compared with visual rating assigned to bridge members during inspection to evaluate the correlation between these two parameters. Visual ratings used in the research are based on rating assigned by the inspector for the year 2005.

Figure 16 shows the correlation between concrete strength and visual rating for simply supported bridge sample. It can be seen that visual rating does not really tend to change with time in a specific trend while concrete strength tend to decrease with time.

For continuous bridge sample, the correlation between visual rating and concrete strength are more comparable (Figure17). Concrete strength decreases with time while visual rating increases, which indicates the presence of visible sign of defects in structure. Higher visual rating represents bad condition.

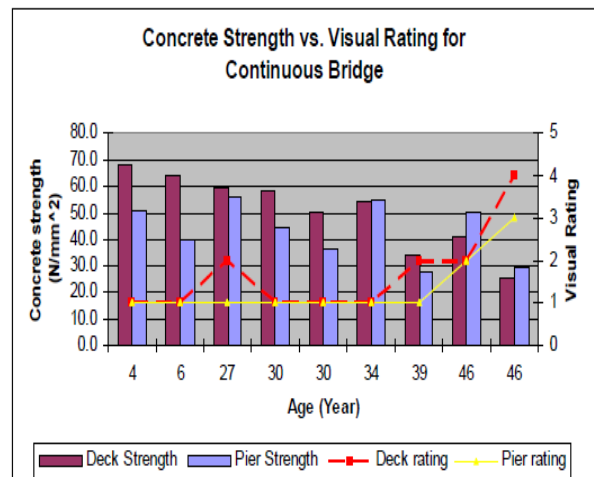
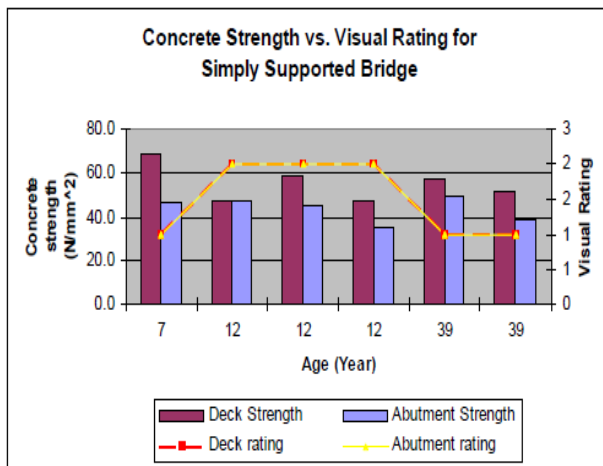

Fig16: Concrete strength in comparison with visual rating (Simply supported bridge sample)

Fig 17: Concrete strength in comparison with visual rating (Continuous bridge sample)

(Source- Azlan Adnan, Sophia C. Ali, Karim Mirasa, (APSEC 2006), 5 – 6 September 2006, Malaysia)

C. Evaluation of performance of reinforced concrete bridges, Turkey

This case study discusses visual inspections of 200 reinforced concrete bridges in Turkey and non-destructive testing applications performed on 10 bridges, which were found to be most deficient. The goal of the study is to discover a relationship between results of non-destructive tests and results of visual inspections.

For visual inspections condition states were used to describe the current status of a bridge or element in terms of deterioration, necessitates actions for improvement of the system. In this research for each element of a bridge, four condition states were defined, and definitions are shown in Table 7.



TABLE VI: the definitions of condition states  
(Source- Masoumi, F., Akgül F., and Mehrabzadeh A, IACSIT, Vol. 5, No. 6, December 2013)

Condition State	Definition
1	No damage or very small damage
2	Small damage
3	High level of damage
4	Critical damage

As a part of a research for development of the bridge management system of Turkey, a network of bridges which contains 200 bridges was chosen, and visual inspections on selected bridges were conducted. As shown in Fig. 18, the results of visual inspections are presented as probability mass functions for condition state of different element types of bridges. Based on these inspections condition states of all damage types of all bridge elements are determined. The Fig. 18 indicated that high percentages of elements have condition state of 1 or 2, which means that the major part of elements is in a good condition. Among selected bridges, 10 bridges with highest condition states (i.e. 10 most deficient bridges) were determined, and for detail assessment of these bridges, non-destructive tests were applied on their members.

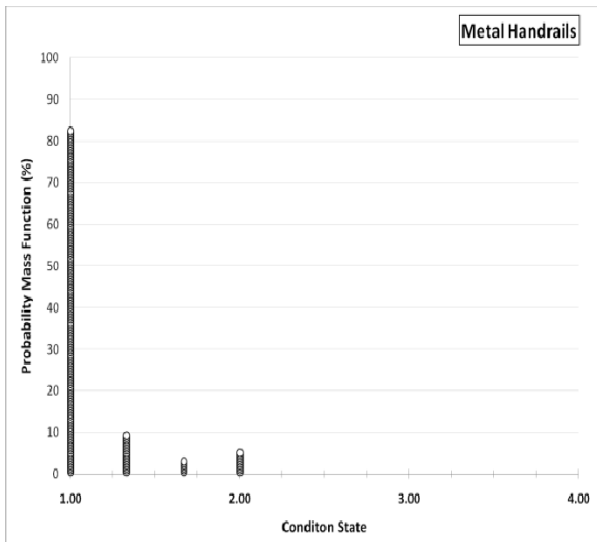

(a)

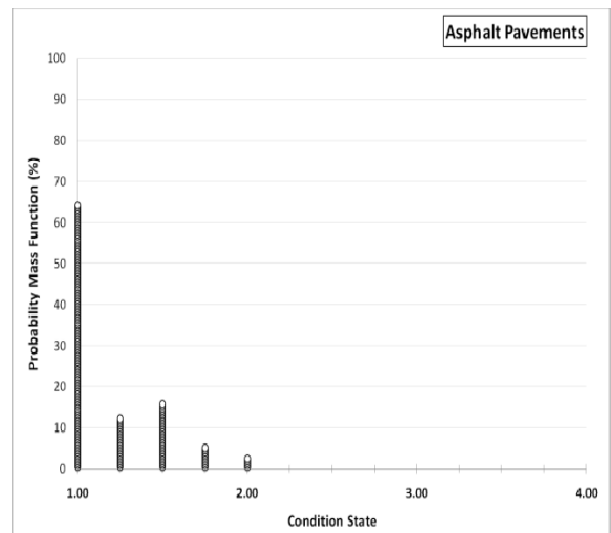

(b)

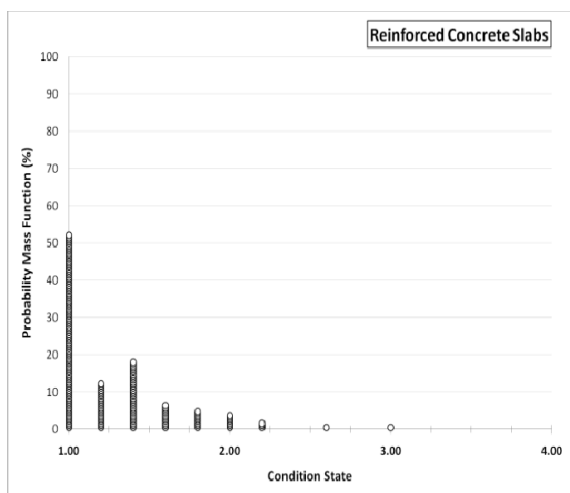

(c)

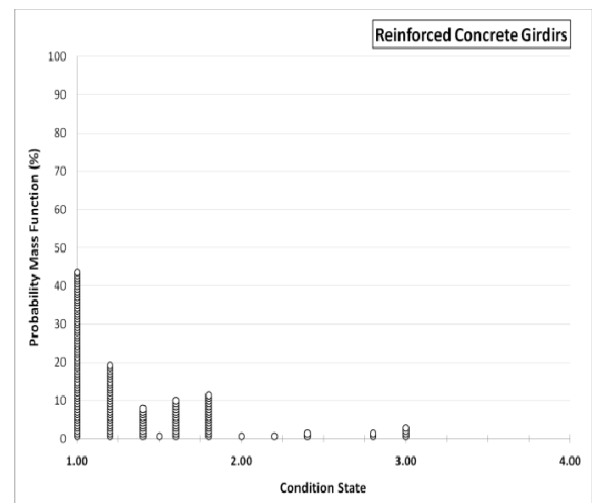

(d)

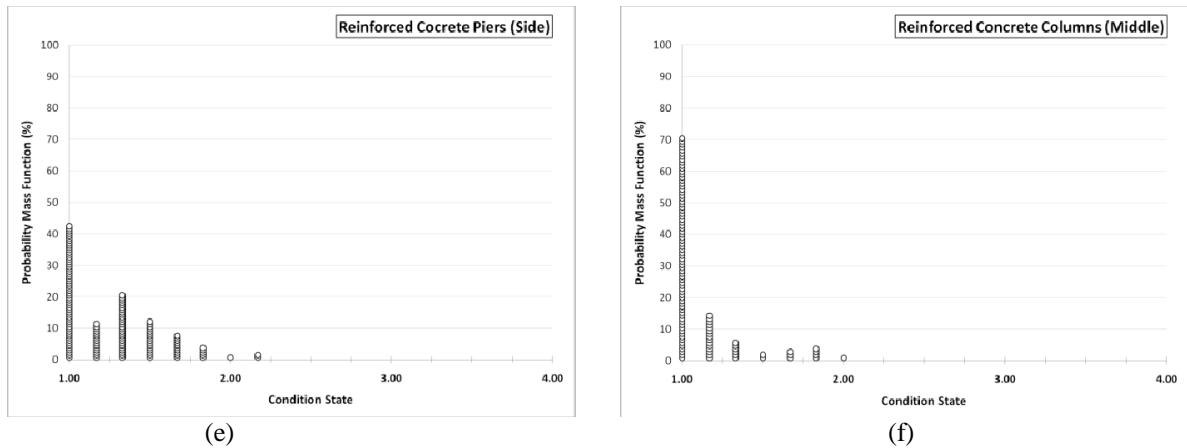

Fig 18: Probability mass function for condition state of element types of 200 bridges

(Source- Masoumi,F., Akgül F., and Mehrabzadeh A, IACSIT, Vol. 5, No. 6, December 2013)

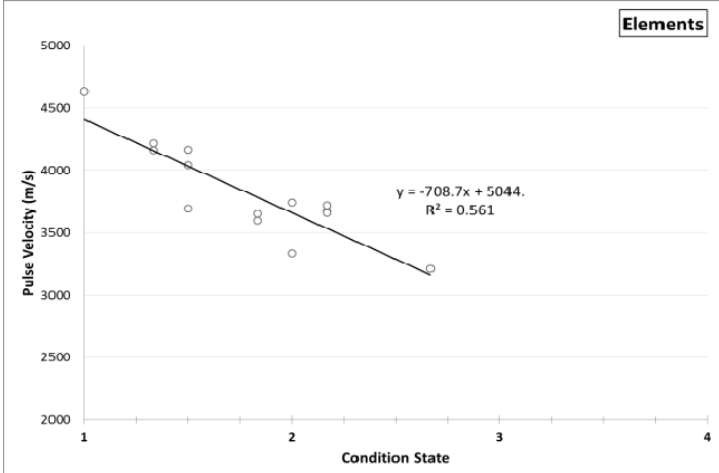

Fig 19: V-meter results versus condition state of elements

(Source- Masoumi,F., Akgül F., and Mehrabzadeh A -, IACSIT, Vol. 5, No. 6, December 2013)

For evaluation of concrete quality, ultrasonic pulse velocity method by V-Meter Mk III device was used on piers and beams of 10 deteriorated bridges. Fig 19 shows the V-meter results versus condition states based on visual inspections. The R squared value of 0.561 indicates that there is not a perfect correlation between two sets of results. The V-meter test results shows that reinforced concrete elements with higher pulse velocity have lower condition states based on visual inspection



Fig 20: Application of ultrasound pulse velocity device on a concrete bridge wing wall.

(Source- Masoumi,F., Akgül F., and Mehrabzadeh A, IACSIT, Vol. 5, No. 6, December 2013)





## V. CONCLUSIONS

Structural health monitoring using non-destructive testing such as ‘Schmidt Rebound Hammer’ and ‘ultrasonic pulse velocity’ methods have been discussed. The Schmidt hammer provides an inexpensive, simple and quick method of obtaining an indication of concrete strength, but accuracy of  $\pm 15$  to  $\pm 20$  per cent is possible only for specimens cast cured and tested under conditions for which calibration curves have been established. The pulse velocity method is an ideal tool for establishing whether concrete is uniform. It can be used on both existing structures and those under construction. Fairly good correlation can be obtained between cube compressive strength and pulse velocity. These relations enable the strength of structural concrete to be predicted within  $\pm 20$  per cent, provided the types of aggregate and mix proportions are constant. Ultrasonic pulse velocity tests have a great potential for concrete control, particularly for establishing uniformity and detecting cracks or defects. From the three case studies discussed in this paper, it can be seen that the NDT methods particularly, the rebound hammer method and the ultrasonic pulse velocity method are effective in condition assessment of bridges. The case study of India shows that there exists a correlation between the results of destructive and non-destructive testing methods in the comprehensive assessment of structure condition. The monitoring of bridges in Malaysia indicates a good correlation between visual rating and strength from Rebound Hammer results. Ratings assigned to the bridge during visual inspection are within an acceptable range in reflecting the bridge strength. Rebound hammer has a potential to be a preliminary test in evaluating the bridge condition. The analysis of bridges in Turkey shows almost perfect correlations between results of non-destructive tests and condition states based on visual inspections. Thus the various NDT techniques available are very useful in estimating the quality and strength of existing concrete bridges, which deteriorate with time and eventually result in failure. During these inspections, the need for urgent repairs, maintenance action, and replacements of bridges can be detected and reported. Based on this report, the administrative bodies can further define priorities and establish programs to apply available resources to the most critical bridges.

## REFERENCES

- [1]. Guidelines on Non-Destructive Testing of Bridges BS - 103 August, 2009, Ministry of Railways, Government of India.
- [2]. Sanjay Kumar & Dalgobind Mahto, “Recent Trends in Industrial and Other Engineering Applications Of Non Destructive Testing: A Review”, International Journal of Scientific & Engineering Research, Volume 4, Issue 9, September-2013 ISSN 2229-5518.
- [3]. Rama Seshu D and Dakshina Murthy N.R., “Non Destructive Testing of Bridge Pier - a Case Study”, the 2nd International Conference on Rehabilitation and Maintenance in Civil Engineering
- [4]. Azlan Adnan, Sophia C. Ali<sup>2</sup>, Karim Mirasa, “Bridge Evaluation Through Non-destructive testing In Comparison With Visual Inspection” , Asia-Pacific Structural Engineering and Construction Conference (APSEC 2006), 5 – 6 September 2006, Kuala Lumpur, Malaysia.
- [5]. Masoumi,F., Akgül F., and Mehrabzadeh A., “Condition Assessment of Reinforced Concrete Bridges by Combined Non destructive Test Techniques”, IACSIT International Journal of Engineering and Technology, Vol. 5, No. 6, December 2013.
- [6]. Non-destructive Test (NDT) of concrete in structures, VicRoads, Technical Note - No. 61: December 2010.
- [7]. Ayaz Mahmood, “Structural Health Monitoring Using Non Destructive Testing Of Concrete”, National Institute of Technology Rourkela 2008.
- [8]. Shetty M.S. (2013) “Concrete Technology Theory and Practicle”, S.Chand